

# Installation Instructions

## CKTES™

### PETK-10 & PETK-11

#### Connection Kit

To be used with \*Thermon Europe Series Cables



 Ex eb IIC T2 to T6  
Ex tb IIIC T260°C to T85°C IP66  
SIRA 10ATEX3368X IECEx SIR10.0195X

 1725

CKTES-1 ART.NO. 420.000.101  
CKTES-2 ART.NO. 420.000.102  
PETK-10 ART.NO. 422.301.631  
PETK-11 ART.NO. 422.301.632

This equipment is tested and approved for hazardous areas zone 1 and zone 2, as well as safe areas and is compliant with the following standards: EN/IEC 60079-0 (2009), EN/IEC 60079-7 (2007), EN/IEC 60079-30-1 (2007), EN/IEC 60079-31 (2009).



\*Thermon Europe Series Cables are in these installation guidelines denominated as TESH.

ISO 9001  
REGISTERED

Connection kit CKTES (Connection Kit Thermon Series Cable) is designed to connect a cold lead cable to a series constant watt heating cable or to repair the Thermon Europe Series (TESH) constant watt heating cables. The CKTES consists of a non-metallic enclosure which does not need to be earthed. Crimp connectors are used to connect the braid and the conductor. They are separated by a non-metallic spacer. To make the CKTES watertight a silicone sealant is used to fill the non-metallic body. This body is sealed off on both sides with a grommet and a non-metallic screw cap.

After installation, the CKTES Termination and in-line splice kit shall be subjected to an insulation resistance test according to EN 60079-30-2, clause 8.3.4, using a test voltage of 500 - 2500 Vdc in accordance with local regulations, applied between the live conductors and the metallic braid of the power or heating cables. The measured insulation resistance must be higher than 20 M $\Omega$ . For other cold lead cables, contact Thermon.

### Important Remarks And Warnings

- Before installing or replacing the product read these instructions completely.
- Thermon is unable to guarantee the performance of the joint when used in combination with non-Thermon products.
- Installation must comply with local requirements for electric heat tracing systems.
- Water and dust ingress must be avoided before, during and after installation, to prevent electrical shock, short circuit or arcing.
- Due to the risk of electric shock, short circuit, arcing and fire caused by product damage or improper usage, installation or maintenance, Thermon heat tracing systems must always be installed in combination with an overcurrent protection device and RCD (Residual Current Device).
- Always take into account the markings on the CKTES concerning the temperature classification and explosion group.
- Modifications to the CKTES are not allowed.
- Before installation or replacement of the CKTES, ensure that the power supply to the system is switched off.
- For crimping lugs, use standard ratchet action crimping tool. Use crimp connectors matching the conductor diameter. Use crimping tools associated with the crimp connectors.
- Avoid skin and eye contact with RTV sealant.
- When stored above 5°C, shelf life will be reduced.

#### For Hazardous Areas:

- Installation must comply with Thermon requirements and be installed in accordance with the regulation as per standard EN/IEC 60079-14 for hazardous areas (where applicable), and/or any other applicable national and local codes.
- This device is not suitable for zone 0. This device can be used in the following ATEX and IECEx zones: zone 1, zone 2, zone 21 and zone 22.
- For power termination, use only ATEX/IECeX approved glands, terminals and junction boxes.
- Installation or replacement of the CKTES in hazardous areas may only be undertaken by qualified personnel with adequate training for the area involved.

CKTES / PETK		
Item	Quantity	Description
1	4	PTFE Screw Caps
2	2	PTFE Housing
3	2	PTFE Spacer
4	4	Silicone Rubber Grommet
5	6-10	Crimp Connectors
6	2	Silicone Sealant Tube

Crimp Connectors CKTES-1		
Item	Quantity	Description
5	2	4 mm <sup>2</sup> x 15 mm
5	4	6 mm <sup>2</sup> x 15 mm
5	2	10 mm <sup>2</sup> x 20 mm
5	2	16 mm <sup>2</sup> x 20 mm

Crimp Connectors CKTES-2		
Item	Quantity	Description
5	2	2,5 mm <sup>2</sup> x 15 mm
5	4	4 mm <sup>2</sup> x 15 mm

PETK-10 (extra items)		
Item	Quantity	Description
7	1	3 m TESH CL-6
8	2	Ground Sleeve
9	4	Wire Pins for conductor & braiding



PETK-11 (extra items)		
Item	Quantity	Description
7	1	3 m TESH CL-2,5
8	2	Ground Sleeve
9	2	Wire Pins for braiding
10	2	Wire Pins for conductor

Tools Required

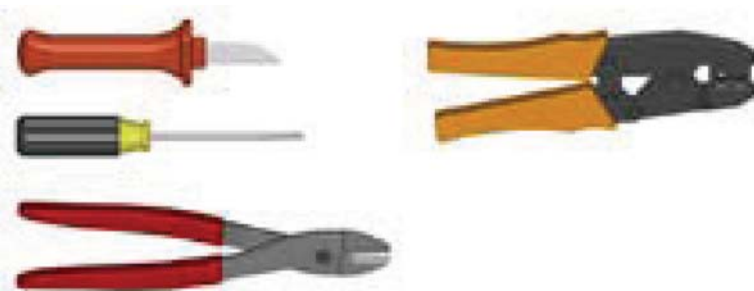

In-Line Connection			
CKTES Kit	Cable Type (Ohm/km)	Crimp Connector size conductor (mm <sup>2</sup> )	Crimp Connector size braiding (mm <sup>2</sup> )
CKTES-1	2,9	16	6
	4,4	10	6
	7	6	6
	10 - 15	4	6
CKTES-2	17,8 - 480	4	4
	600* - 8000*	2,5	4

\* Double fold heating cable conductor

Cold-Lead Connection				
PETK Kits	Cable Type (Ohm/km)	Cold-Lead Type	Crimp Connector size conductor (mm <sup>2</sup> )	Crimp Connector size braiding (mm <sup>2</sup> )
PETK-10	2,9	CL Not required	-	-
	4,4 - 15	CL-6	10	6
PETK-11	17,8 - 480	CL-2,5	4	4
	600* - 8000*	CL-2,5	4	4

\* Double fold heating cable conductor

**Step 1**

First determine the correct circuit length, then slide the screw cap and the rubber grommet over the heating cable and cold lead cable (in case of a power connection). Slide the housing over (one of) the heating cable(s).

Items drawings	
Item	Description
A	Heating Cable
B	Cold Lead/Heating Cable
C	Screw Cap
D	Spacer
E	Sealant
F	Crimp Connector
G	Grommet
H	Housing
I	Braiding
J	Conductor
K	Outerjacket
L	Primary Insulation

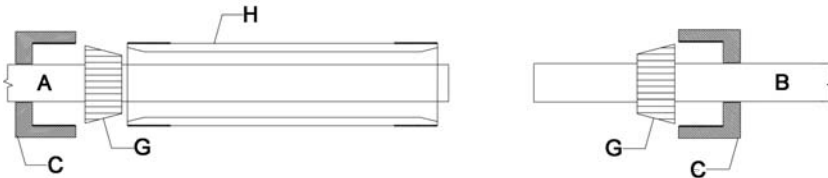

**Step 2**

Remove 60 mm\* outer jacket from both cables (\*for TESH 600 up to TESH 8000, 75 mm). Separate braid strands at the end of the outer jacket of the heating cable(s) and cold lead cable (PETK-10/11). Push back the braid away from the heating cable to form a pigtail. Remove glass ceramic/polyamide tape. Pull the insulated conductor through the opening in the braid of both cables.

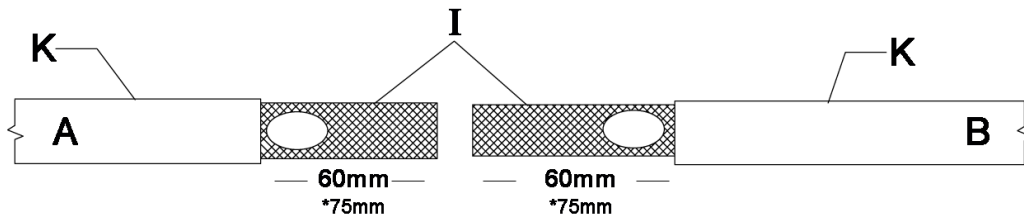

**Step 3**

Twist the braid into a pig tail and trim the ends. Cut the braid of the Heating Cable at approximately 30 mm and 50 mm for the Cold Lead / 2<sup>nd</sup> Heating cable. Cut the conductors at 50 mm\* and 30 mm\* (\*for TESH 600 up to 8000, cut 65 and 45 mm).

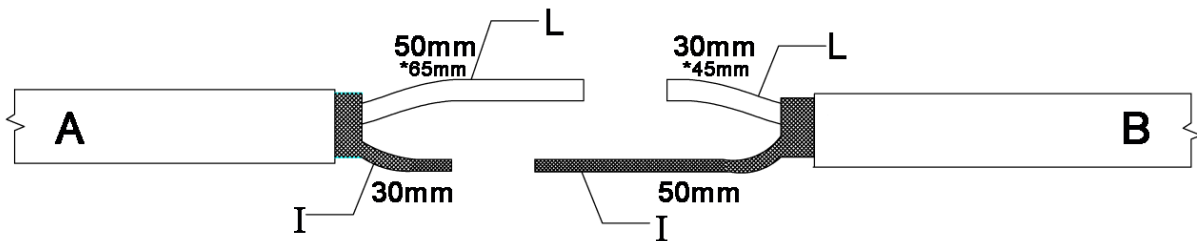

**Step 4**

Remove primary insulation of the heating conductor and cold lead over a length of 15 mm (\*in case of Cold lead or TESH 2,9 and TESH 4,4 remove 20 mm, for TESH 600 up to 8000 remove 30 mm). \*\*Side view of spacer in image.

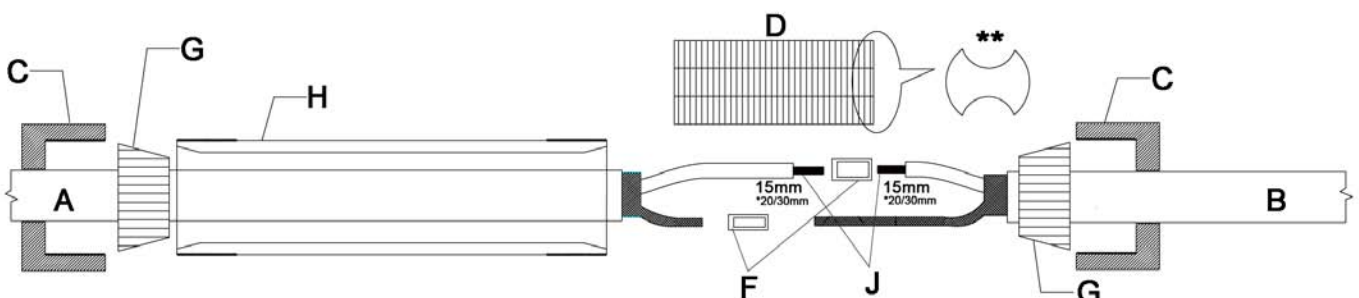

### Step 5

Insert the bare conductor of both the Cold Lead/Heating Cable and Heating Cable into the crimp connector and ensure complete overlap of conductors inside the crimp connector. Crimp the crimp connector with matching crimping tool. Follow the same procedure for terminating the braid of the Cold Lead/Heating Cable and Heating Cable. For cable type TESH 600 up to TESH 8000, the heating cable conductor shall be folded double within the crimp\*. For the correct Crimp Connector type, see table page 3.

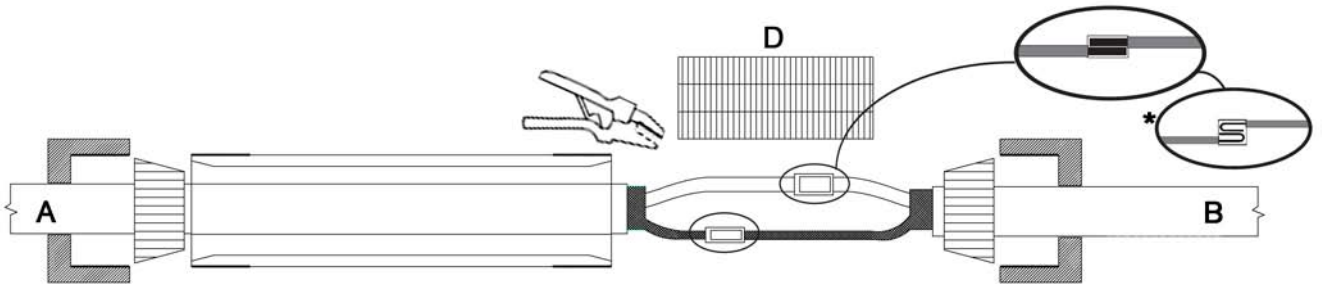

### Step 6

Place the Spacer between both crimped connectors and ensure that both the leads and crimped connector are properly placed inside the slots. Put a rich amount of silicone sealant on the crimped connectors and in the slots. \*Sealant on Crimp connectors.

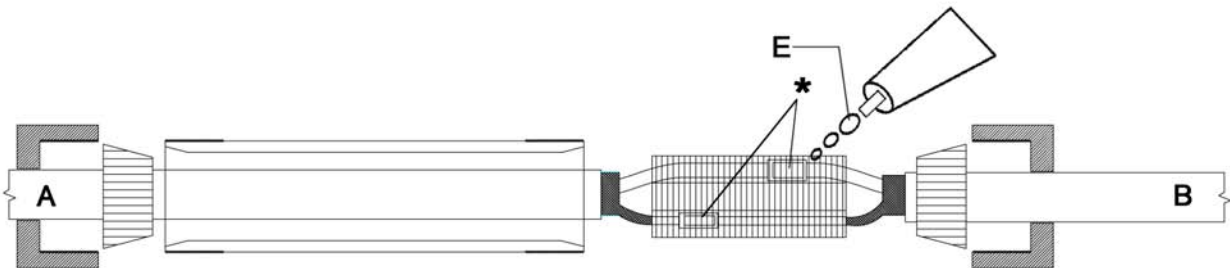

### Step 7

Slide the Housing over the assembled connections. Ensure assembled connection is positioned in the centre of the Housing. Fill one end of the Housing with sealant ensuring that there are no air pockets and push the grommet into the Housing. Ensure the joint and cable ends are held in position. Tighten the screw cap, repeat the operation at the other end. Wipe off excessive sealant.

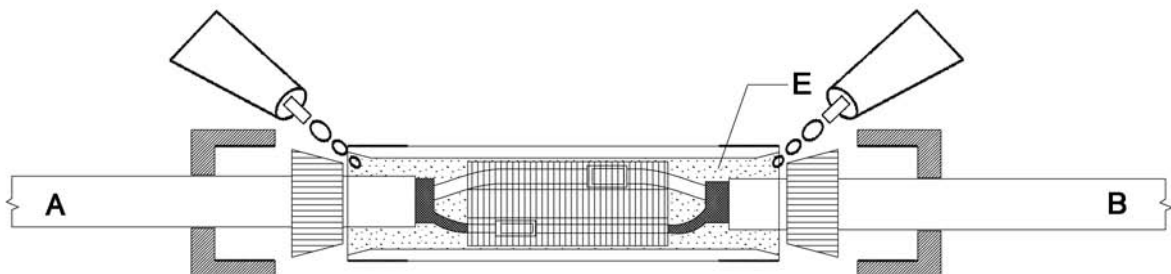

**Step 8**

Mount the CKTES/PETK on a flat surface, with expansion loop of 150 mm in the cables. Heating Cable/Cold Leads and joint secured in place using fibre fixing tape. Application of tape shall allow a small degree of movement at the joint and cables to cater for potential expansion and contraction of the pipeline. Do not over-tighten.

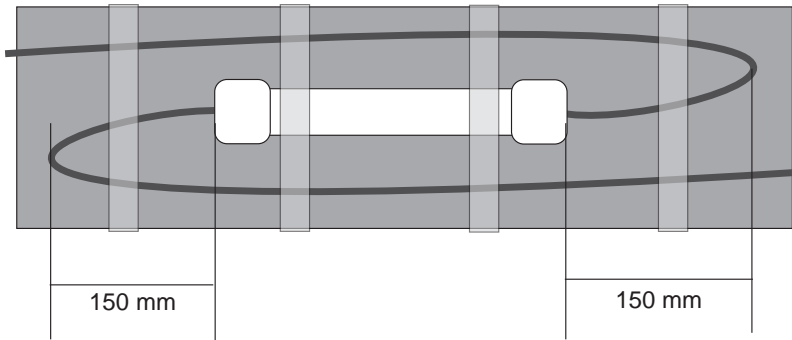

**Step 9**

Do not move the assembled CKTES/PETK for minimum 24 hours for complete curing.

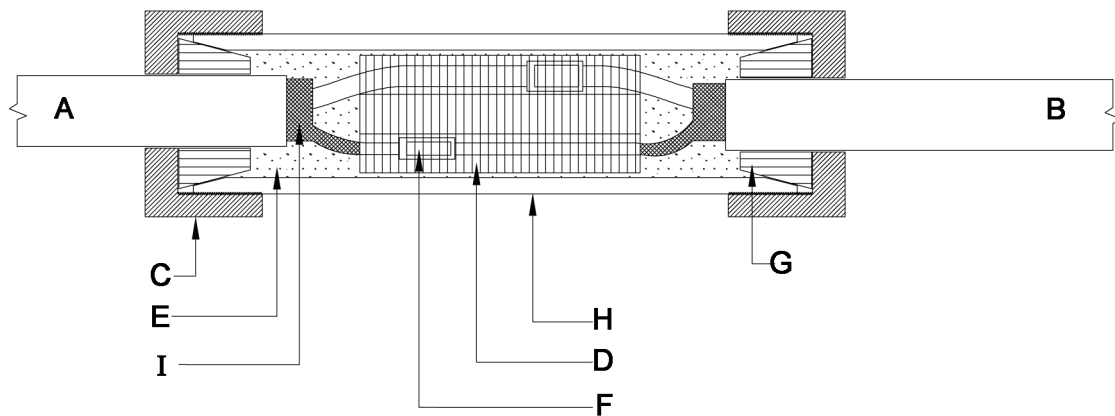

**Description**

Power and End Termination Kit PETK for Thermon TESH series constant watt heating cables in conjunction with Thermon JB-K-EX, TED, Terminator ZP-R, ZT-R in hazardous areas. In non-hazardous areas with expediter .../XP PLUS ...-IND. See also installation instructions of the relevant heat tracing cable and junction/thermostat enclosures.

**Step 1**

Cut and remove cold lead cable overjacket (150 mm).

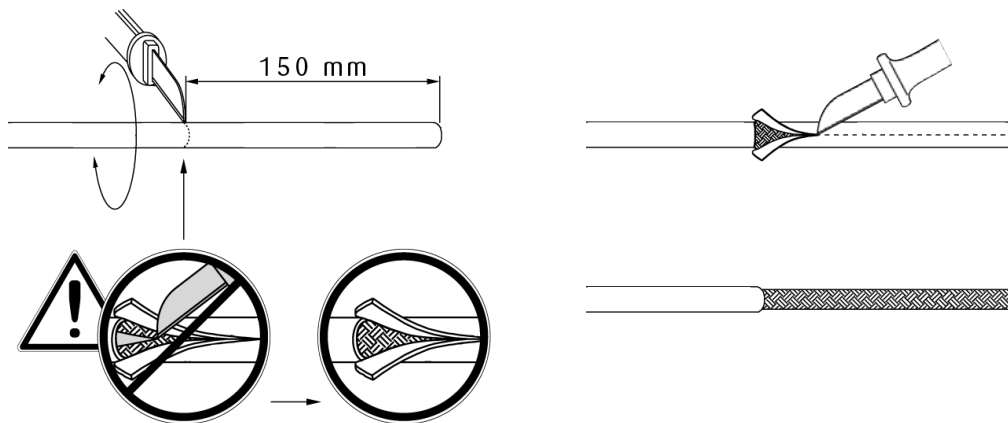

**Step 2**

Separate braid strands at edge of overjacket and pull cable through opening in braid. Twist braid into a pigtail. Trim ends of braid. Remove glass ceramic tape.

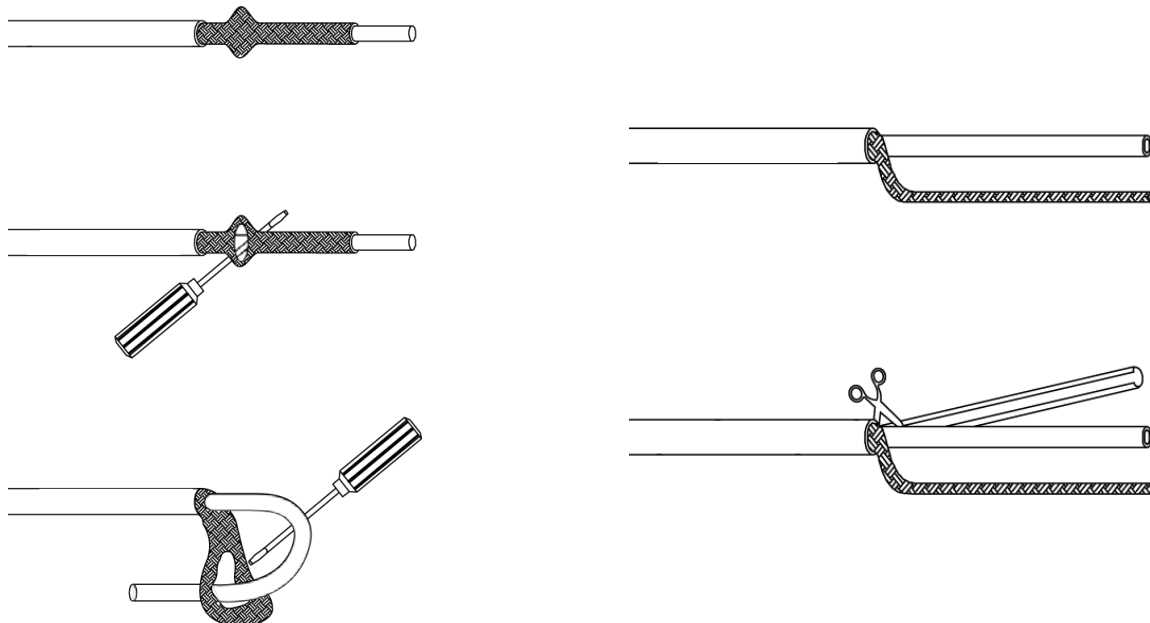



**Step 3**

Cut and remove (10 mm) primary insulation jacket to reveal the bare conductor.

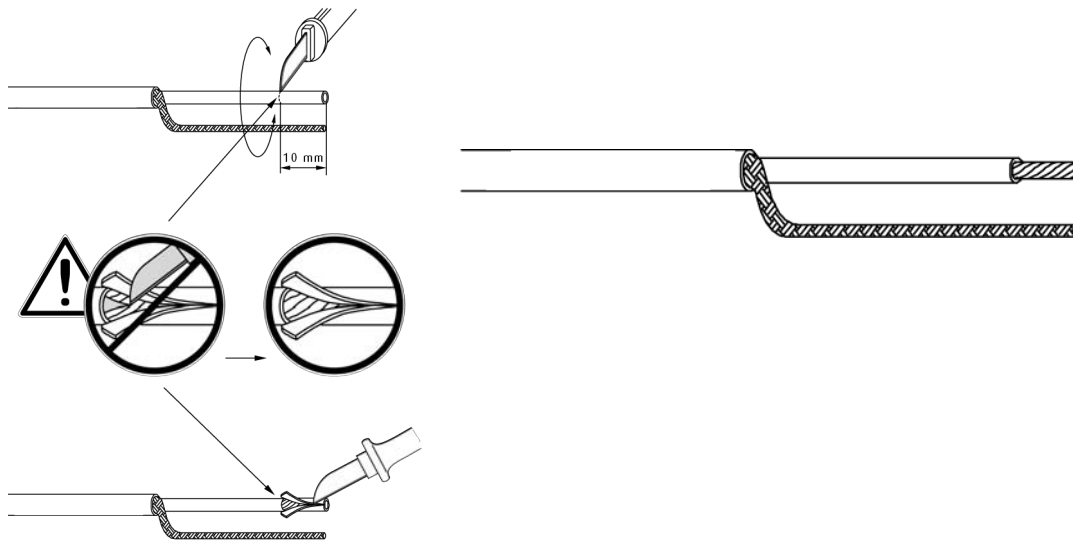

**Step 4**

Slide green/yellow ground sleeve over twisted braid. Crimp conductor wire pins on each conductor. Crimp braid wire pin on twisted braid.

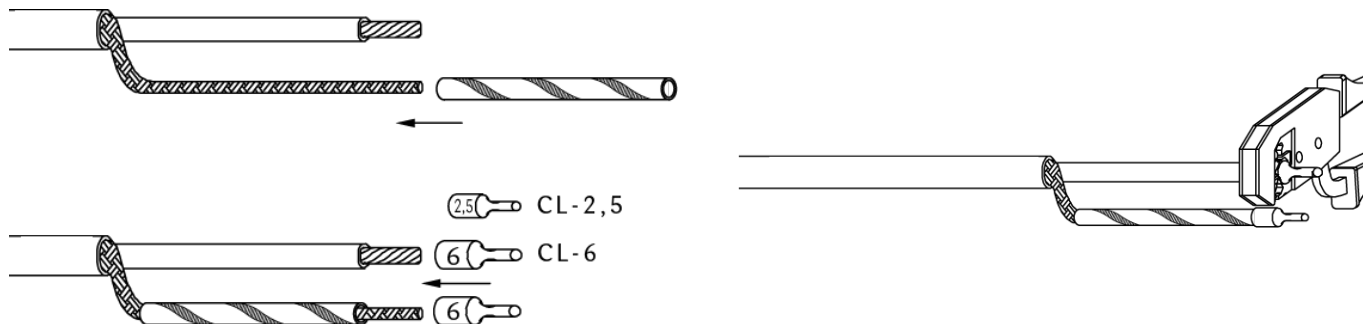

**Addresses**

European Headquarters  
 Boezemweg 25 PO Box 205  
 2640 AE Pijnacker The Netherlands  
 Phone: +31(0)15-3615370

Corporate Headquarters  
 100 Thermon Dr. PO Box 609  
 San Marcos, TX 78667-0609  
 USA

For the Thermon office near you, visit us at  
[WWW.THERMON.COM](http://WWW.THERMON.COM)